

**FOR CAR USE ONLY/ POUR APPLICATION AUTOMOBILE UNIQUEMENT/ NUR FÜR
AUTOMOBIL GEBRAUCH/ PARA USO EN AUTOMÓVILES/ SOLO PER L'UTILIZZO IN
AUTOMOBILE/ ТОЛЬКО ДЛЯ ИСПОЛЬЗОВАНИЯ В АВТОМОБИЛЯХ**



Advanced Dash Cam

DVR-C310R

DVR-C310S

RVC-C310

• **OWNER'S MANUAL**

Please read before using this equipment.

• **MODE D'EMPLOI**

Veillez lire avant d'utiliser cet appareil.

• **BEDIENUNGSANLEITUNG**

Lesen Sie diese Bedienungsanleitung bitte vor
Gebrauch des Gerätes.

• **MANUAL DE OPERACIÓN**

Léalo antes de utilizar este equipo.

• **ISTRUZIONI PER L'USO**

Si prega di leggere prima di utilizzare il attrezzatura.

• **РУКОВОДСТВО ПО ЭКСПЛУАТАЦИИ**

Прочтите настоящее руководство перед началом
использования оборудования.

FCC Statement

This device complies with Part 15 of the FCC Rules. Operation is subject to the following two conditions: (1) this device may not cause harmful interference, and (2) this device must accept any interference received, including interference that may cause undesired operation.

This equipment has been tested and found to comply with the limits for a Class B digital device, pursuant to Part 15 of the FCC Rules. These limits are designed to provide reasonable protection against harmful interference in a residential installation. This equipment generates, uses and can radiate radio frequency energy and, if not installed and used in accordance with the instructions, may cause harmful interference to radio communications. However, there is no guarantee that interference will not occur in a particular installation. If this equipment does cause harmful interference to radio or television reception, which can be determined by turning the equipment off and on, the user is encouraged to try to correct the interference by one or more of the following measures:

- Reorient or relocate the receiving antenna.
- Increase the separation between the equipment and receiver.
- Connect the equipment to an outlet on a circuit different from that to which the receiver is connected.
- Consult the dealer or an experienced radio/TV technician for help.
- This appliance and its antenna must not be co-located or operation in conjunction with any other antenna or transmitter.
- A minimum separation distance of 20cm must be maintained between the antenna and the person for this appliance to satisfy the RF exposure requirements.

FCC CAUTION: Any changes or modifications to the equipment not expressly approved by the party responsible for compliance could void your authority to operate the equipment.

FCC ID: 2ADTG-DVRC310R

Information to user : RSS-247

This equipment complies with IC radiation exposure limits set forth for an uncontrolled environment. This equipment should be installed and operated with minimum distance 20 cm between the radiator & your body.

This device contains licence-exempt transmitter(s)/receiver(s) that comply with Innovation, Science and Economic Development Canada's licence-exempt RSS(s).

Please be cautioned the changes or modifications not expressly approved by the party responsible for compliance could void the user's authority to operate the equipment.

Notice: Operation is subject to the following two conditions : (1) this device may not cause interference, and (2) this device must accept any interference, including interference that may cause undesired operation of the device.

This Class B digital apparatus complies with Canadian ICES-003.

IC: 12594A-DVRC310R

Contents

Operating Instructions	4	4. Using the mobile viewer	23
1. Product overview	8	4.1 Connect the product to a smartphone	23
1.1 Included items	8	4.2 Viewing the mobile viewer screen layout	23
1.1.1 DVR-C310R (2 camera, USA/Canada only)	8	5. Using the PC viewer	24
1.1.2 DVR-C310S (1 camera)	9	5.1 System requirements	24
1.1.3 RVC-C310 (Rear view only)	9	5.2 Learning about the PC viewer	24
1.2 Part names	10	5.2.1 Installing the PC viewer	24
1.2.1 Front camera (main unit) - front view	10	5.2.2 PC viewer screen layout (for Windows)	25
1.2.2 Front camera (main unit) - rear view	10	5.2.3 Playing recorded videos on the PC viewer (for Windows)	26
1.2.3 Rear camera (RVC-C310)	11	5.2.4 PC viewer screen layout (for Mac)	27
1.3 Removing and inserting the memory card	11	5.2.5 Playing recorded videos on the PC viewer (for Mac)	28
1.4 Overviewing connection diagram	12	6. Settings	29
1.4.1 2 Camera connection diagram (DVR-C310R / RVC-C310)	12	6.1 Managing the memory card	29
1.4.2 1 Camera connection diagram (DVR-C310S)	13	6.2 Setting the Camera	29
1.4.3 Car charger connection diagram	13	6.3 Setting recording features	30
2. Installing the product	14	6.4 Read Safety settings	31
2.1 Installing the front camera (main unit)	14	6.5 Configuring the system settings	31
2.1.1 Selecting an installation location	14	7. Accessing the product information	32
2.1.2 Securing the product	14	7.1 Viewing product information	32
2.1.3 Connecting the power cable with the car charger	16	7.2 Accessing and configuring the GPS	32
2.2 Installing the rear camera	16	8. Upgrading the firmware	33
2.2.1 Selecting an installation location	16	9. Troubleshooting	34
2.2.2 Securing the rear camera	17	10. Specifications	35
2.2.3 Connecting the rear camera cable	18		
2.3 Installing the external GPS receiver	19		
3. Using recording features	20		
3.1 Turning the product on or off	20		
3.2 Learning about file storage locations	20		
3.3 Using the continuous recording feature	21		
3.4 Recording manually	21		
3.5 Using parking mode	22		

Operating Instructions

Points to Observe for Safe Usage

Read this manual carefully before using the system components. They contain instructions on how to use this product in a safe and effective manner. Alpine cannot be responsible for problems resulting from failure to observe the instructions in this manual.

This manual uses various pictorial displays to show you how to use this product safely and to alert you to potential dangers resulting from improper connections and operation. Following are the meanings of these pictorial displays. It is important to fully understand the meanings of these pictorial displays in order to use this manual and the system properly.

Safety symbols in this guide



"Warning" - This symbol means Important Instructions. Failure to heed them can result in serious injury or death.



"Caution" - This symbol means Important Instructions. Failure to heed them can result in Injury or material property damage.



"Note" - This symbol means useful information that helps users better utilize the product's features.

Safety information for proper use

Driving and product operation



- **MINIMIZE DISPLAY VIEWING WHILE DRIVING.** Viewing the display may distract the driver from looking ahead of the vehicle and cause an accident.
- **OPERATION OF THE SYSTEM WHILE DRIVING IS DANGEROUS.** Users should stop vehicle before operating the software.
- **THIS SOFTWARE IS DESIGNED FOR USE EXCLUSIVELY IN THE UNIT.** It cannot and may not be used in conjunction with other hardware.

Power supply and product installation



- **DO NOT WATCH VIDEO WHILE DRIVING.** Watching the video may distract the driver from looking ahead of the vehicle and cause an accident.
- **DO NOT DISASSEMBLE OR ALTER.** Doing so may result in an accident, fire or electric shock.
- **USE ONLY IN CARS WITH A 12 VOLT NEGATIVE GROUND.** (Check with your dealer if you are not sure.) Failure to do so may result in fire, etc.
- **USE THE CORRECT AMPERE RATING WHEN REPLACING FUSES.** Failure to do so may result in fire or electric shock.
- **DO NOT BLOCK VENTS OR RADIATOR PANELS.** Doing so may cause heat to build up inside and may result in fire.
- **USE THIS PRODUCT FOR MOBILE 12V APPLICATIONS.** Use for other than its designed application may result in fire, electric shock or other injury.
- **MAKE THE CORRECT CONNECTIONS.** Failure to make the proper connections may result in fire, battery drain or product damage.
- **BEFORE WIRING, DISCONNECT THE CABLE FROM THE NEGATIVE BATTERY TERMINAL.** Failure to do so may result in electric shock or injury due to electrical shorts.
- **DO NOT ALLOW CABLES TO BECOME ENTANGLED IN SURROUNDING OBJECTS.** Arrange wiring and cables in compliance with the manual to prevent obstructions when driving. Cables or wiring that obstruct or hang up on places such as the steering wheel, gear lever, brake pedals, etc. can be extremely hazardous.
- **DO NOT SPLICE INTO ELECTRICAL CABLES.** Never cut away cable insulation to supply power to other equipment. Doing so will exceed the current carrying capacity of the wire and result in fire or electric shock.
- **DO NOT DAMAGE PIPE OR WIRING WHEN DRILLING HOLES.** When drilling holes in the chassis for installation, take precautions so as not to contact, damage or obstruct pipes, fuel lines, tanks or electrical wiring. Failure to take such precautions may result in fire.
- **DO NOT USE BOLTS OR NUTS IN THE BRAKE OR STEERING SYSTEMS TO MAKE GROUND CONNECTIONS.** Bolts or nuts used for the brake or steering systems (or any other safety-related system), or tanks should NEVER be used for installations or ground connections. Using such parts could disable control of the vehicle and cause fire etc.
- **DO NOT INSTALL IN LOCATIONS WHICH MIGHT HINDER VEHICLE OPERATION, SUCH AS THE STEERING WHEEL OR SHIFT LEVER.** Doing so may obstruct forward vision or hamper movement etc. and results in serious accident.
- **DO NOT OPERATE ANY FUNCTION THAT TAKES YOUR ATTENTION AWAY FROM SAFELY DRIVING YOUR VEHICLE.** Any function that requires your prolonged attention should only be performed after coming to a complete stop. Always stop the vehicle in a safe location before performing these functions. Failure to do so may result in an accident.

Children



- **KEEP SMALL OBJECTS SUCH AS SCREWS OUT OF THE REACH OF CHILDREN.** Swallowing them may result in serious injury. If swallowed, consult a physician immediately.

Other information about the product

Product management and operation



- **HALT USE IMMEDIATELY IF A PROBLEM APPEARS.** Failure to do so may cause personal injury or damage to the product. Return it to your authorized Alpine dealer or the nearest Alpine Service Center for repairing.
- **HAVE THE WIRING AND INSTALLATION DONE BY EXPERTS.** The wiring and installation of this unit requires special technical skill and experience. To ensure safety, always contact the dealer where you purchased this product to have the work done.
- **USE SPECIFIED ACCESSORY PARTS AND INSTALL THEM SECURELY.** Be sure to use only the specified accessory parts. Use of other than designated parts may damage this unit internally or may not securely install the unit in place. This may cause parts to become loose resulting in hazards or product failure.
- **ARRANGE THE WIRING SO IT IS NOT CRIMPED OR PINCHED BY A SHARP METAL EDGE.** Route the cables and wiring away from moving parts (like the seat rails) or sharp or pointed edges. This will prevent crimping and damage to the wiring. If wiring passes through a hole in metal, use a rubber grommet to prevent the wire's insulation from being cut by the metal edge of the hole.
- **DO NOT INSTALL IN LOCATIONS WITH HIGH MOISTURE OR DUST.** Avoid installing the unit in locations with high incidence of moisture or dust. Moisture or dust that penetrates into this unit may result in product failure.



- Use a soft dry cloth for periodic cleaning of the product. For more severe stains, please dampen the cloth with water only. Anything else has the chance of dissolving the paint or damaging the plastic.
- Be sure the temperature inside the vehicle is between +45°C (+113°F) and 0°C (+32°F) before turning your unit on.
- If you have problems, do not attempt to repair the unit yourself. Return it to your Alpine dealer or the nearest Alpine Service Station for servicing.

Warning and Notices



- This device should never be mounted in or to a vehicle in a way that interferes with the operations of the vehicle, including, but not limited to, airbags, lane detection systems, navigation device, and so forth. Doing so may result violation of state or national laws, injury, or death. Always mount this device so that it does not obstruct the driver's view. Any fines, penalties, or damages resulting from improperly or illegally operating this this device are not the responsibility of Alps Alpine Co., Ltd. or any of its affiliates, subsidiaries, principals, officers, employees or shareholders.
- Do not operate or manipulate this device while driving, such as change settings, review footage, access information, change the device location or angle, or otherwise manipulate this device while driving. Do not allow this device to distract from safe driving.
- Do not mount this device where driver or passenger head impact is likely in the case of an accident, including, but not limited to areas directly in front of the driver or passengers.
- It may be a violation of state or national laws to secure this device to a dash board or windshield. It is the user's responsibility to know and follow the applicable laws in the jurisdictions where this device is used.
- Do not use this device contrary to the instructions in this manual or contrary to national and state laws.
- It may be a violation of state or national laws to video or audio record someone with this device without their consent. This may include audio recording a passenger in your vehicle without his or her consent. It is the user's responsibility to know and follow the applicable laws in the jurisdictions where this device is used.
- Publishing the recordings made with this device on social media or other places on the internet without consent of those in the recordings may violate state or national privacy laws. It is the user's responsibility to know and follow the applicable laws in the jurisdictions where this device is used.
- This product uses lithium batteries. For your safety, do not overcharge this device. Do not leave this device plugged in when the vehicle is not turned off. Do not leave this device in extreme temperatures. Damaged, overcharged, or misused lithium batteries can explode or otherwise cause fire. Failure to heed these warning may result in injury or death.

1. Product overview

1.1 Included items

Ensure that all the items are included when you open the product box.



- The standard items may change without prior notice.
- GPS reception may be affected by interference from the vehicle's windshield, particularly those treated with anti-UV protective coating, or built-in defroster.

1.1.1 DVR-C310R (2 camera, USA/Canada only)

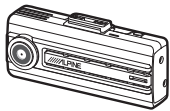

Front camera (main unit)



Rear camera



Mount



Hardwiring cable



Car charger



Quick start guide /
User guide / Warranty /
Registration card
(stored in the microSD card)

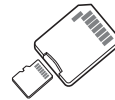

microSD card with adapter
(consumable)



Dash cam recording
warning sticker



Cable clamp holder



Rear camera cable

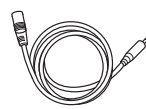

Rear camera extension
cable



Rear camera connection
cable

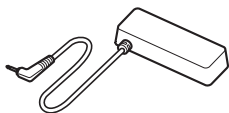

External GPS receiver

1.1.2 DVR-C310S (1 camera)

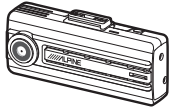

Front camera (main unit)



Mount



Hardwiring cable



microSD card with adapter
(consumable)



Quick start guide /
User guide
(stored in the microSD card)



Cable clamp holder



Dash cam recording
warning sticker

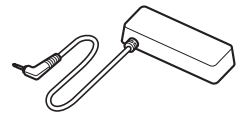

External GPS receiver

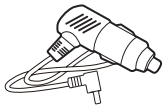

Car charger

1.1.3 RVC-C310 (Rear view only)



Rear camera



Rear camera cable



Rear camera extension
cable



Rear camera connection
cable



Cable clamp holder

1.2 Part names

1.2.1 Front camera (main unit) - front view

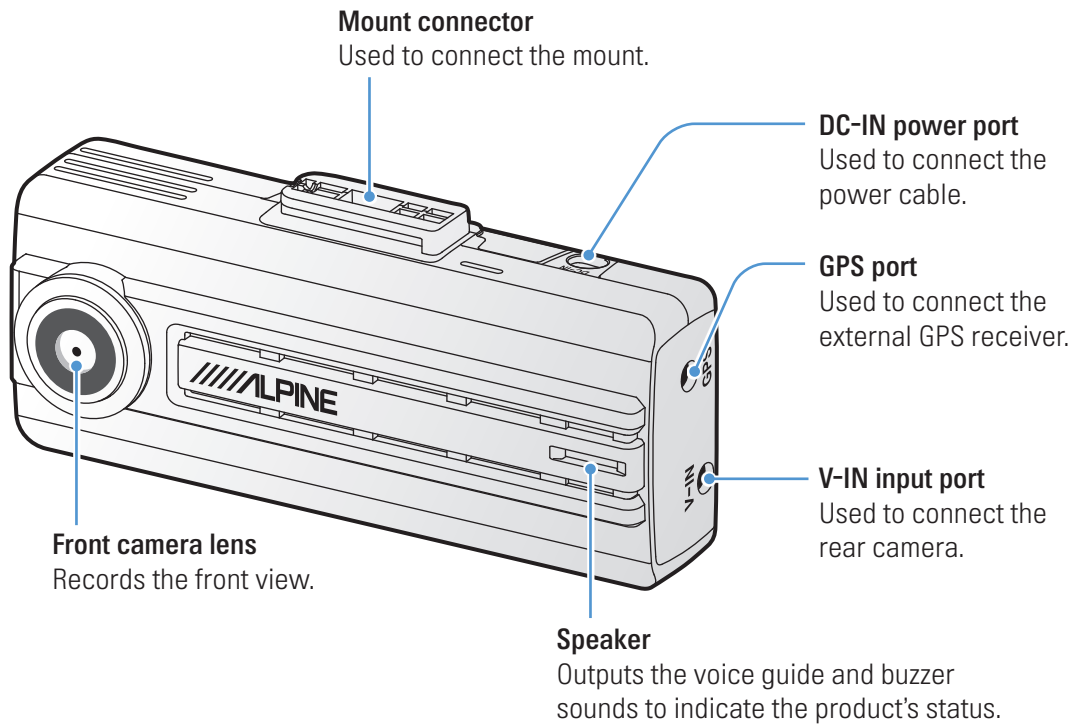

1.2.2 Front camera (main unit) - rear view

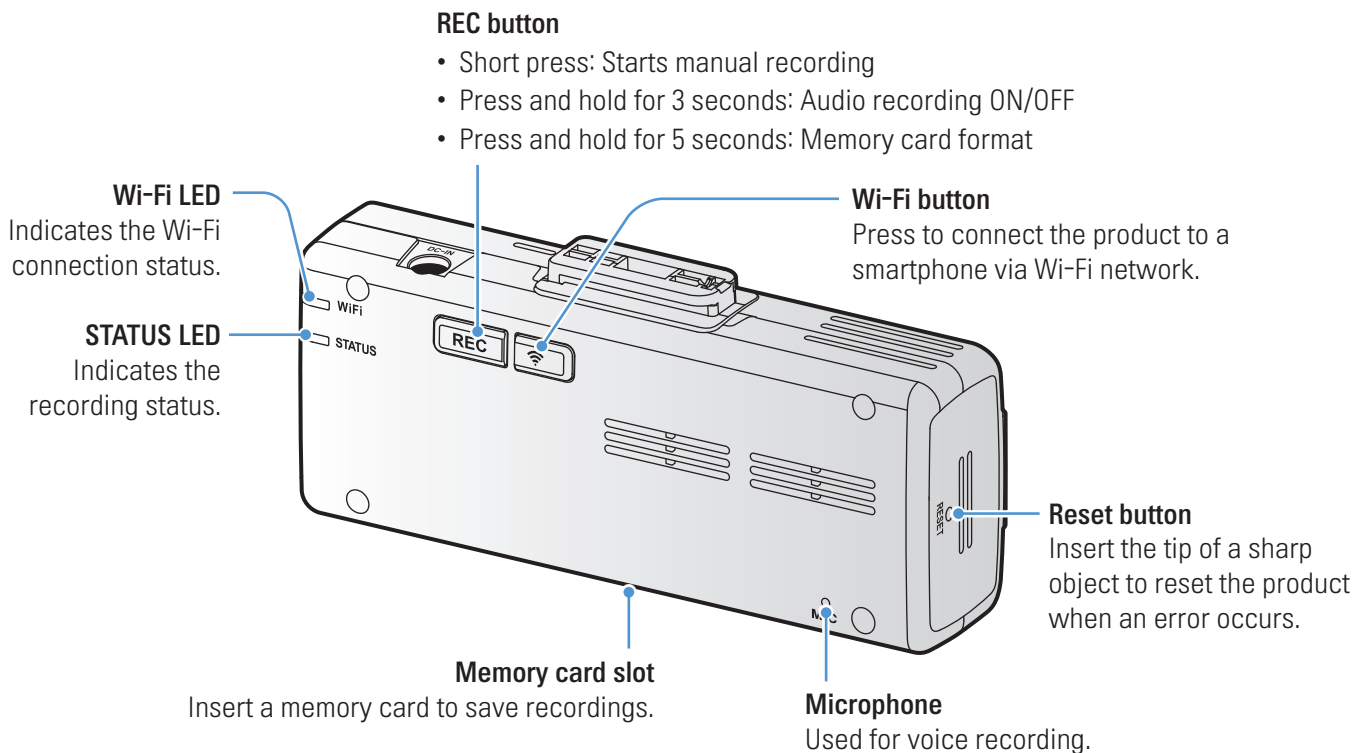

1.2.3 Rear camera (RVC-C310)

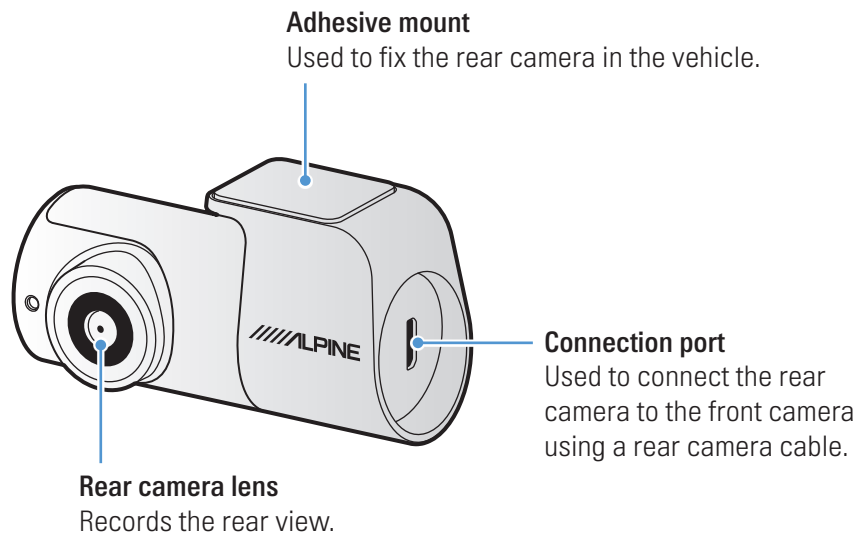

1.3 Removing and inserting the memory card

Follow the instructions to remove the memory card from the product or to insert the memory card into the product.

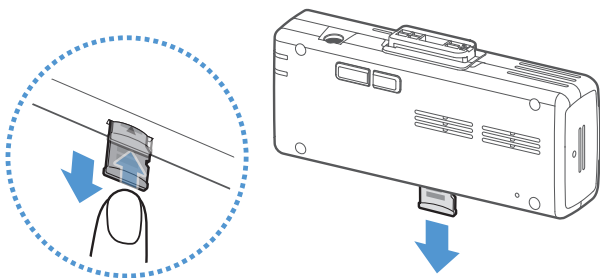

Before removing the memory card, ensure that the product is turned off. Gently push the bottom of the memory card with your fingernail to release it, and then remove it from the product.

To insert the memory card into the memory card slot, ensure that the metal contacts on the memory card are facing toward the product's buttons, and insert it into the slot until you hear a click.



- Ensure that the product is turned off before removing the memory card. The recorded video files may be corrupted or lost if you remove the memory card while the product is on.
- Ensure that the memory card is in the correct direction before inserting it into the product. The memory card slot or the memory card may be damaged if it is inserted incorrectly.
- Use only authentic memory cards from Alpine. Alpine does not guarantee the compatibility and normal operation of third-party memory cards.



To prevent loss of recorded video files, periodically back up the video files on a separate storage device.

1.4 Overviewing connection diagram

Follow the connection diagram to properly install the product.



The connection diagram is for reference only. The product must be professionally installed in the vehicle by an Alpine authorized dealer/a trained specialist mechanic.

1.4.1 2 Camera connection diagram (DVR-C310R / RVC-C310)

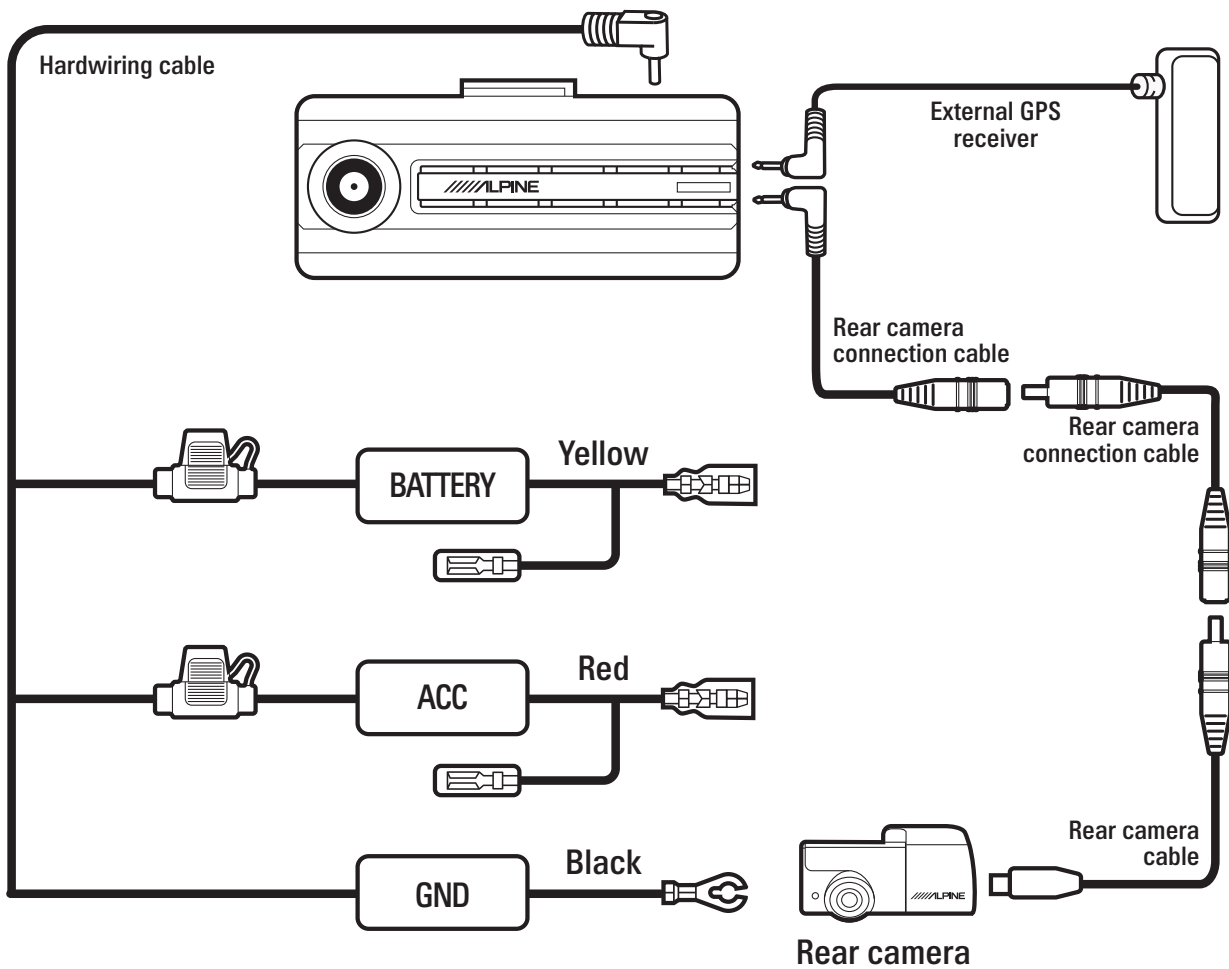

1.4.2 1 Camera connection diagram (DVR-C310S)

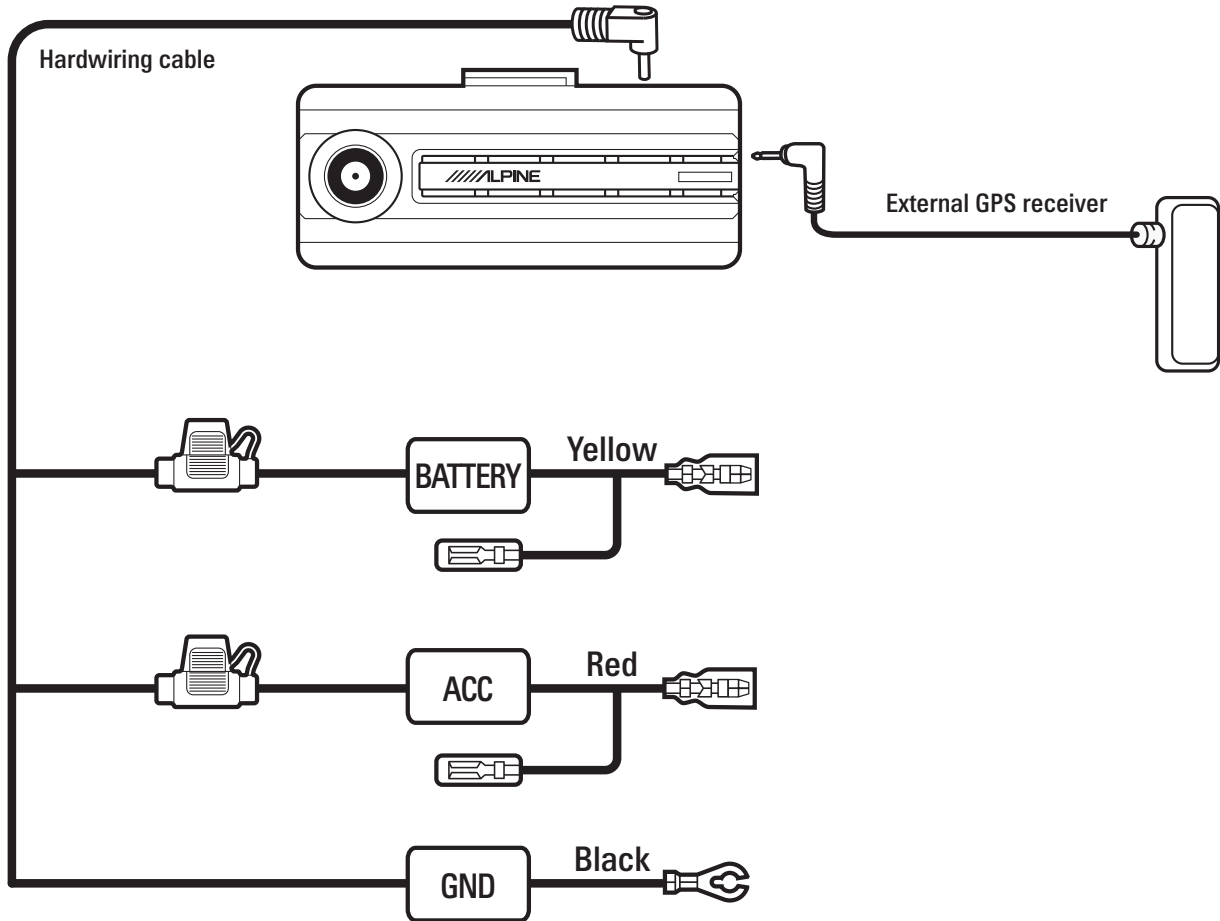

1.4.3 Car charger connection diagram

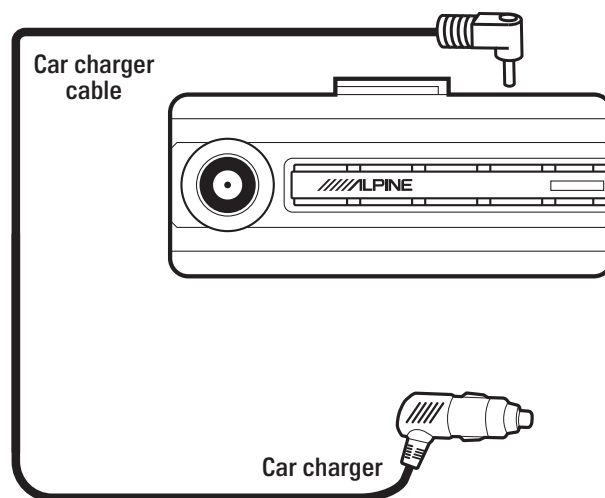

2. Installing the product

2.1 Installing the front camera (main unit)

Follow the instructions to properly install the product.

2.1.1 Selecting an installation location

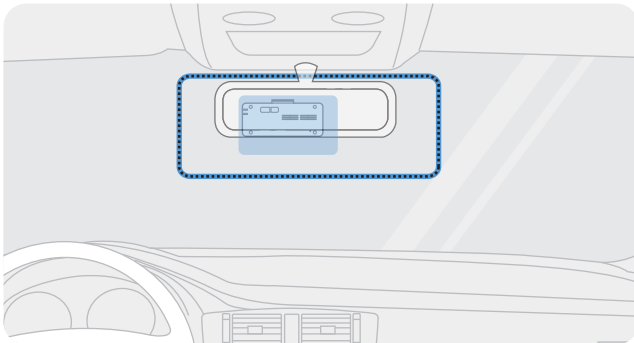

Select an installation location that can record the entire view in front of the vehicle without obstructing the driver's vision. Ensure that the front camera lens is located in around the center of the windshield.

Keep it as far away as possible from other antennas.

Should not be installed on vehicle equipped with front radar or front camera ADAS systems.

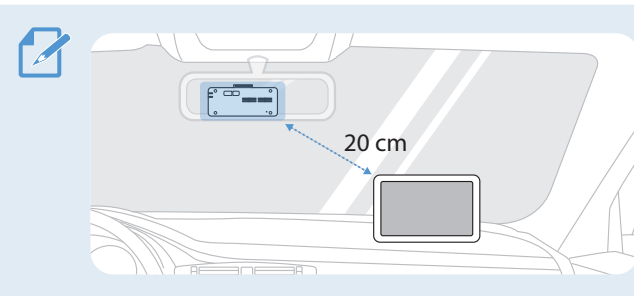

If a GPS navigating device is installed on the dashboard, its GPS reception may be affected depending on the dashboard camera's installation location.

Adjust the installation location of the GPS navigating device to ensure that the two devices are separated by at least 20 centimeters (approximately 8 inches).

2.1.2 Securing the product

Follow the instructions to secure the product at the installation location.

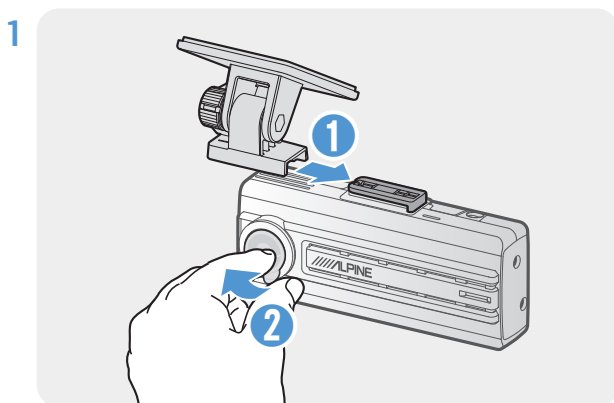

Align the mount to the mount rail on the product, and then slide it until you hear a click (1). Then, carefully remove the protective film (2).

2 After determining the installation location, wipe the installation location on the windshield with a dry cloth.

3

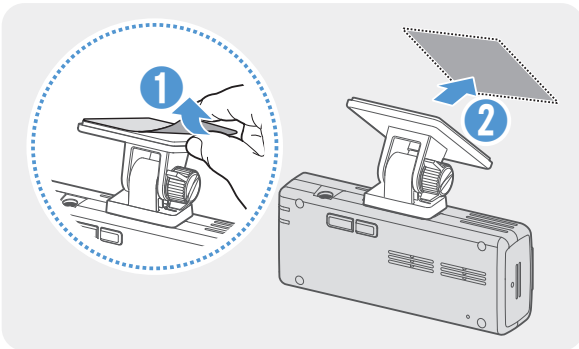

Remove the protective film from the adhesive mount, and then press the mount to the installation location.

4

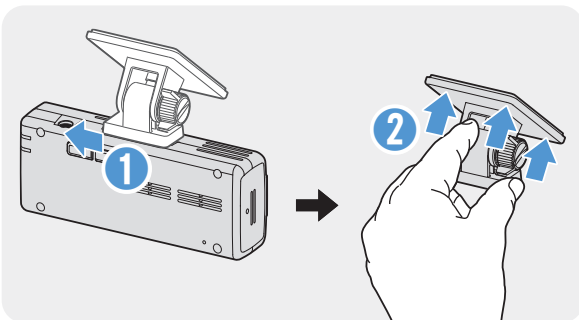

Remove the product from the mount and push the mount against the windshield to ensure that the mount is firmly fixed.

5

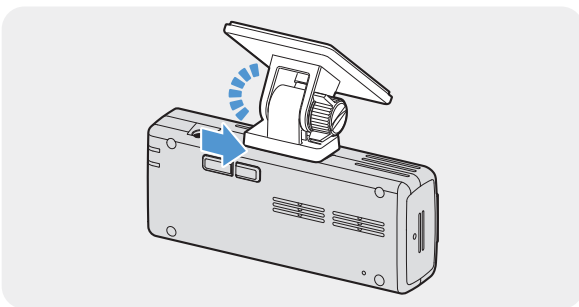

Align the product to the mount, and then slide it into the locking position until you hear a click.



- The product may fall and be damaged during vehicle operation if it is not firmly fixed to the mount.
- If you need to remove the mount from the windshield to alter the installation location, be careful not to damage the windshield's film coat.

6

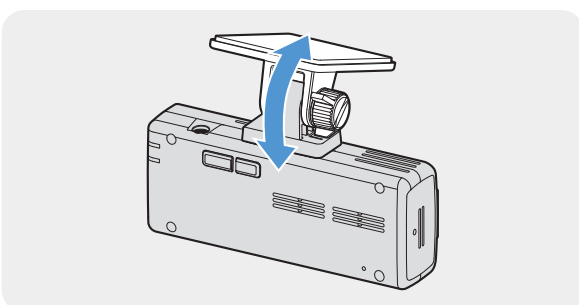

Set the vertical angle of the camera appropriately and tighten the screw of the mount firmly.



To confirm the camera angle, record a video after installation and check the video using the mobile viewer or the PC viewer. If necessary, adjust the camera angle again. For more information about the mobile viewer or the PC viewer, refer to "4. Using the mobile viewer" or "5. Using the PC viewer".

2.1.3 Connecting the power cable with the car charger

When the engine and electrical accessories are turned off, connect the car charger.

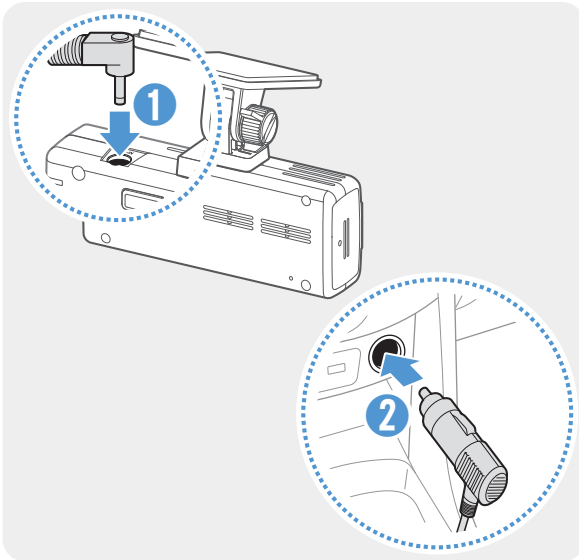

Connect the cigar socket power cable to the product's DC-IN power connector and insert the cigar jack into the vehicle's power socket.



The location and specifications of the power socket may differ by vehicle make and model.



- Use an authentic cigar socket power cable. If you use another manufacturer's cable, the product may be damaged or electrical fire or electrocution may result due to the voltage difference.
- Do not cut or modify the power cable yourself. Doing so may damage the product or the vehicle.
- For safe driving, arrange the cables to prevent the driver's vision from being obstructed or interfering with driving.

2.2 Installing the rear camera

Refer to the following instructions to properly install the rear camera.

2.2.1 Selecting an installation location

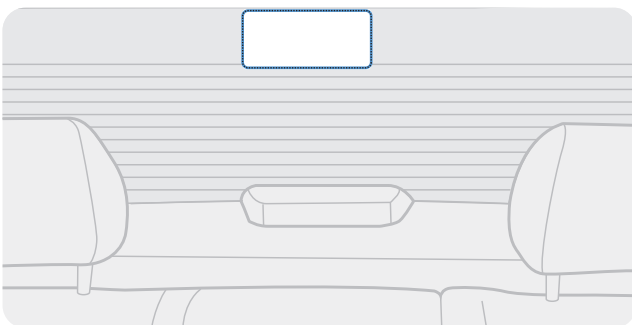

Select a location on the rear windshield where there is no defrost grid wire and the camera can record the entire rear view.



- For vehicles with a sunshade attached to the rear windshield, select a location where using the sunshade will not interfere with camera operation.
- The adhesive part of the rear camera should not touch the defrost grid.

2.2.2 Securing the rear camera

Refer to the following instructions to secure the product to the installation location.

- 1 After determining the installation location, wipe the installation surface of the windshield with a dry cloth.



Check the installation location before you secure the rear camera to the rear windshield. After securing the rear camera to the windshield, it is hard to remove the camera or change the installation location due to the strong adhesive.

2

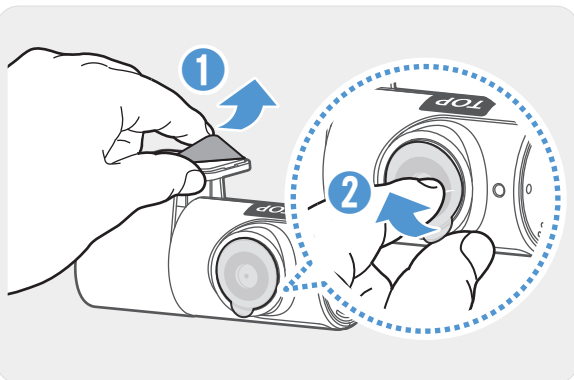

Remove the protective film from the adhesive mount and camera lens.



Before attaching the rear camera, check the position of the lens. The **TOP** label should be above the lens.

3

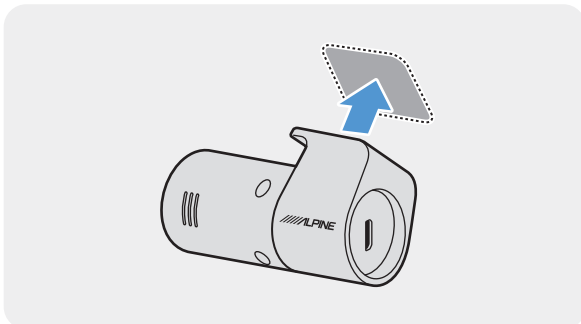

Attach the product with the Alpine logo facing inside the vehicle and press the adhesive tape firmly to secure the camera.



If the product is installed in reverse, the rear view will be recorded upside down.

4

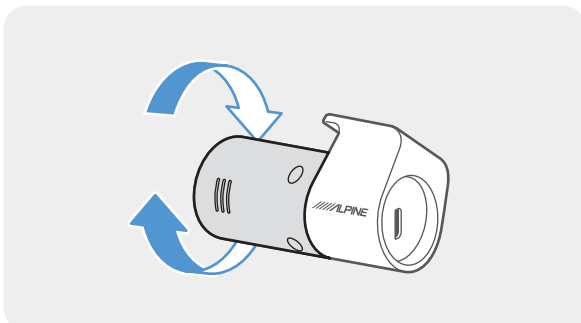

Adjust the camera's vertical angle.

2.2.3 Connecting the rear camera cable

Power off the product and connect the rear camera cable to the front camera (main unit).

1

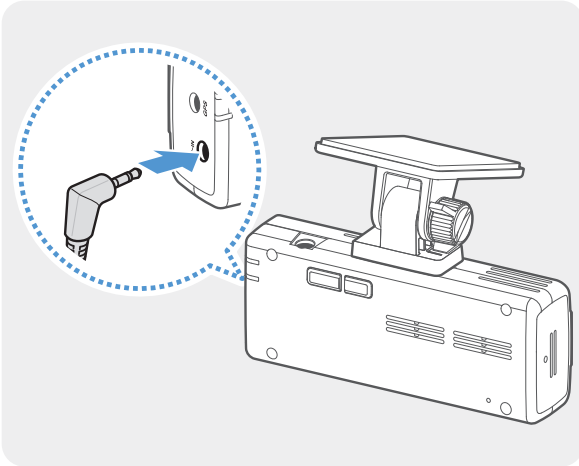

Connect one end of the rear camera cable to the front camera's V-IN port.

2

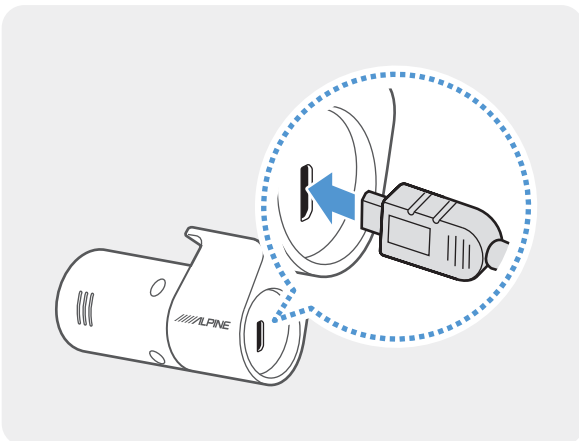

Connect the other end of the rear camera cable to the rear camera's connection port.



For safe driving, arrange the cables to prevent the driver's vision from being obstructed or interfering with driving.

3 Turn on the ACC or start the engine to check if the product is powered on. After the product is powered on, the Status LED and the voice guidance will be turned on.



The product is powered on when the ACC mode is turned on or when the engine starts.

2.3 Installing the external GPS receiver

To activate the ADAS feature or record driving information (the speed and location), follow the instructions and install the external GPS receiver on the upper part of the front windshield. Install the external GPS receiver near the product, taking its cable length into account.

1

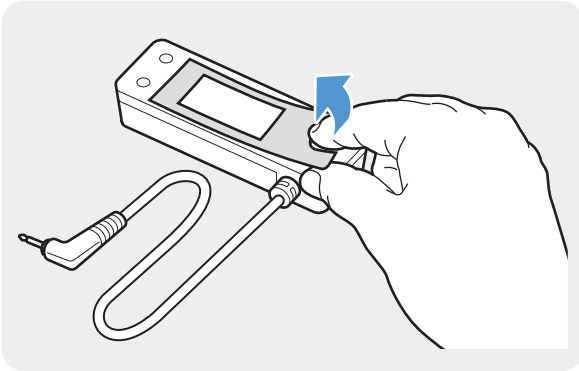

Remove the film from the back of the external GPS receiver.

2

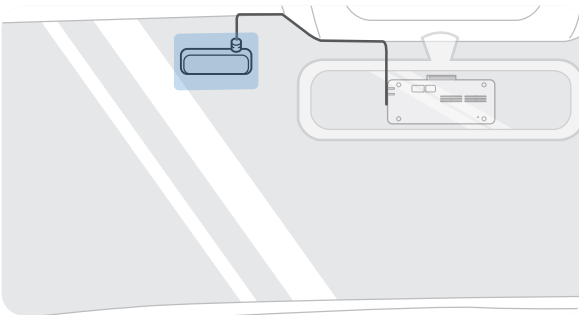

Attach the external GPS receiver's adhesive surface to the upper part of the front windshield and press the adhesive part firmly to secure it.



Before installation, make sure the external GPS receiver's cable length is sufficient and check the cable routing path.

3

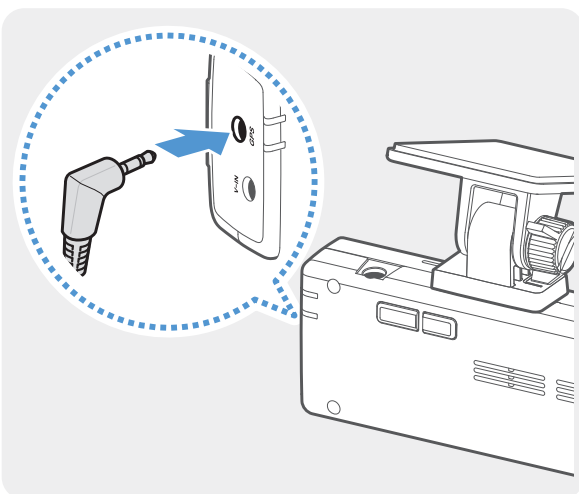

Connect the external GPS receiver to the product's GPS connector.



Check the GPS connector location again before connecting the GPS receiver. If you connect the external GPS receiver to the DC-IN power connector, the pins inside the port may be damaged.

4 Turn on the ACC or starts the engine to check that the product is powered on. After the product is powered on, the Status LED and the voice guide are turned on.



The product is powered on when electric accessories are turned on or the engine starts.

3. Using recording features

3.1 Turning the product on or off

The product is turned on automatically and continuous recording starts when you turn on the ACC or start the engine.



Wait until the product is completely booted up after turning it on, and then begin operating the vehicle. The video recording does not begin until the product is completely turned on (booted up).

3.2 Learning about file storage locations

Videos are stored in the following folders according to their recording mode.

On the mobile viewer	Continuous	Continuous Incident	Manual Recording	Motion Detection	Parking Incident
In the memory card	cont_rec	evt_rec	manual_rec	motion_rec	parking_rec



Play videos on Window/Mac/Smartphone by using the **ALPINE Recording Viewer** application. If you play videos by inserting the memory card in devices such as a smartphone or a tablet PC, the video files may be lost.



A file name is composed of the recording start date and time, and the recording option.

REC_	YYYY_MM_DD	HH_MM_SS	F
REC_	2020_08_01	10_25_30	R



Recording conditions

- F: Front camera
- R: Rear camera

3.3 Using the continuous recording feature

Connect the power cable to the product's DC-IN power port and then turn on the vehicle's electrical accessories or start the engine. The status LED and the voice guide are turned on, and the continuous recording starts.

During continuous recording, the product operates as follows.

Mode	Operation description	STATUS LED
Continuous recording	During driving, videos are recorded in 1 minute segments and stored in the "cont_rec" folder.	 (light on)
Incident continuous recording*	When an impact to the vehicle is detected, a video is recorded for 20 seconds, from 10 seconds before the detection to 10 seconds after the detection, and stored in the "evt_rec" folder.	 (flickers)

* When an impact to the vehicle is detected during continuous recording, incident continuous recording starts with a buzzer sound.



- The video recording does not begin until the product is completely booted up and the GPS signal is received. After the booting up is finished you may begin operating the vehicle.
- When incident continuous recording starts, the buzzer sounds as a notification.
- To enable recording, insert a memory card into the product.

3.4 Recording manually

You can record a scene you want to capture while driving and store it as a separate file.

To start manual recording, press the **REC** button. Then, manual recording will start with the voice guide. During manual recording, the product operates as follows.

Mode	Operation description	STATUS LED
Manual recording	When you press the REC button, a video will be recorded for 1 minute, from 10 seconds before to 50 seconds after pressing the button, and stored in the "manual_rec" folder.	 (flickers)

3.5 Using parking mode

When the product is connected to the vehicle via the hardwiring cable, the operating mode is switched to parking mode with the voice guide after the engine or electrical accessories are turned off.







Parking mode operates only when the hardwiring cable is connected. The hardwiring cable must be professionally installed to the vehicle by an Alpine authorized dealer/a trained specialist mechanic.



- To use all recording modes, insert a memory card into the product.
- Depending on the battery charging status of the vehicle, the duration of parking mode may differ. If you want to use parking mode for an extended period, check the battery level to prevent battery depletion.

If you do not want to use parking mode or you want to change the mode settings, from the mobile viewer, tap **Dash Cam Settings > Record Settings**.

Refer to the following table to set the **Parking Mode** options.

Option		Operation description	STATUS LED
Motion Detection	No motion or impact detected	Monitors movement in the area or impacts to the vehicle. Video will be recorded only when motion or an impact is detected.	 (flickers slowly)
	Motion detected	When a moving objects is detected while parking, a video is recorded for 20 seconds, from 10 seconds before detection to 10 seconds after detection, and stored in the "motion_rec" folder.	 (flickers)
	Impact detected	When an impact is detected while parking, a video is recorded for 20 seconds, from the moment 10 seconds before detection to 10 seconds after detection, and stored in the "parking_rec" folder.	 (flickers)
Energy Saving	No impact detected	Monitors impacts to the vehicle. Video will be recorded only when an impact is detected.	Off
	Impact detected	When an impact is detected while parking, a video is recorded for 20 seconds from within 1 second after detection and stored in the "parking_rec" folder.	 (flickers)
OFF		The product is powered off when electric accessories and the engine are turned off.	Off



If parking mode settings are changed, the videos recorded with the previous settings will be deleted. To prevent data loss, back up all parking mode videos before changing parking mode settings.

4. Using the mobile viewer

You can view and manage recorded videos and configure various product features on your smartphone.



- The following are the mobile phone requirements for using the **ALPINE Recording Viewer** application:
 - Android 7.0 (Nougat) or higher
 - iOS 11.4 or higher
- The Wi-Fi password is required when you connect the product to a smartphone for the first time. Enter “123456789” in the password input field.

4.1 Connect the product to a smartphone

- 1 On your smartphone, open the Google Play Store or Apple App store and download and install **ALPINE Recording Viewer**.
- 2 Run **ALPINE Recording Viewer**.
- 3 Tap **Dash cam connection is required.** at the bottom of the screen and follow the on-screen instructions to connect the product to a smartphone.

4.2 Viewing the mobile viewer screen layout

The following provides brief information about the mobile viewer’s screen layout.

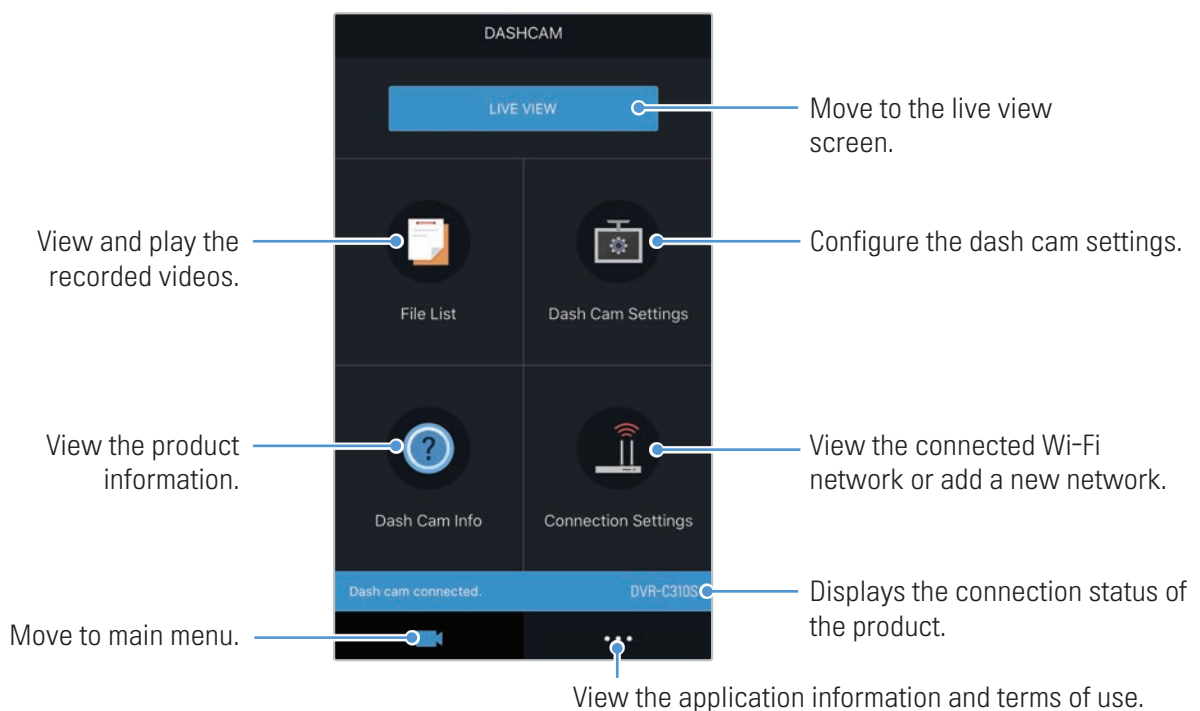

5. Using the PC viewer

You can view and manage the recorded videos and configure various product features on your PC.

5.1 System requirements

The following are the system requirements for running the PC viewer.

- Processor: Intel Core i5, or higher
- Memory: 4 GB or more
- Operating system: Windows 7 or later (64-bit is recommended), macOS X10.8 Mountain Lion or later
- Other: DirectX 9.0 or higher / Microsoft Explorer version 7.0 or higher



The PC viewer will not operate properly on PC systems running an operating system other than those listed in the system requirements.

5.2 Learning about the PC viewer

5.2.1 Installing the PC viewer



You can download the latest PC viewer software from the Alpine website.

The PC viewer installation file (setup.exe) is stored in the root folder of the memory card that is provided with the product. Follow the instructions to install the PC viewer on your PC.

- 1 Insert the memory card into a memory card reader connected to your PC.
- 2 Move the installation file to the desktop, run it, and complete the installation according to the instructions given in the installation wizard.
After the installation is complete, there will be a shortcut icon to ALPINE Recording PC Viewer.

5.2.2 PC viewer screen layout (for Windows)

The following provides brief information about the PC viewer's screen layout.

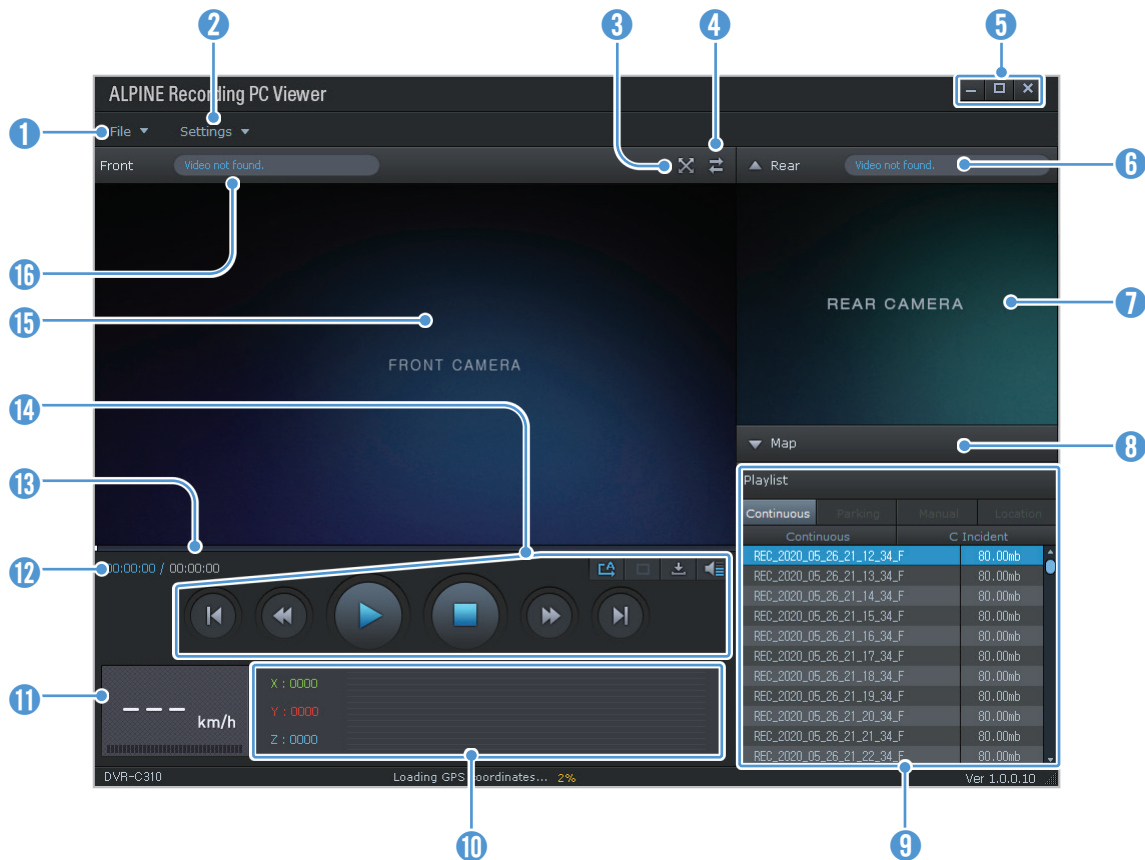

Number	Description
1	Open a file, or save a video with a different name.
2	View or configure the dash cam settings, and set the language for the PC viewer.
3	Display the current video in full screen. Tap the Back  button to return to the previous screen.
4	Switch between the front and rear videos.
5	Minimize, expand, or close the software.
6	Displays the rear camera video file name.
7	Displays the recorded rear camera video.
8	Display the map screen.
9	Displays the playlist.
10	Indicates the G sensor value at the time of recording.
11	Indicates the vehicle's driving speed at the time of recording.
12	Displays the current and total running time of the current video.
13	Displays the progress of video playback.
14	Play or control a video.
15	Displays the recorded front camera video.
16	Displays the front camera video file name.

5.2.3 Playing recorded videos on the PC viewer (for Windows)

Follow the instructions to play recorded videos.

- 1 Turn off the product and remove the memory card.
- 2 Insert the memory card into a memory card reader connected to your PC.
- 3 Double-click the shortcut to the PC viewer to open the program. The video files in the memory card will be automatically added to the playlist in the bottom-right corner of the PC viewer screen. The playlist section layout is as follows.

Select a folder.

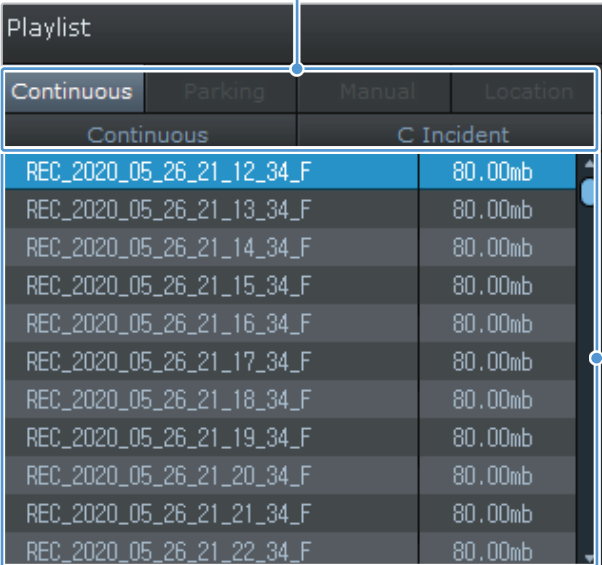

Displays a list of videos in the selected folder.

Playlist			
Continuous	Parking	Manual	Location
Continuous		C Incident	
REC_2020_05_26_21_12_34_F			80.00mb
REC_2020_05_26_21_13_34_F			80.00mb
REC_2020_05_26_21_14_34_F			80.00mb
REC_2020_05_26_21_15_34_F			80.00mb
REC_2020_05_26_21_16_34_F			80.00mb
REC_2020_05_26_21_17_34_F			80.00mb
REC_2020_05_26_21_18_34_F			80.00mb
REC_2020_05_26_21_19_34_F			80.00mb
REC_2020_05_26_21_20_34_F			80.00mb
REC_2020_05_26_21_21_34_F			80.00mb
REC_2020_05_26_21_22_34_F			80.00mb

- 4 Double-click a video file after selecting a video folder, or click the Play (▶) button after selecting a video file. The selected video file will be played.

 If the video files on the memory card are not automatically added to the playlist when you run the PC viewer, click **File** > **Open**, select the removable storage device for the memory card, and click **Confirm**.

5.2.4 PC viewer screen layout (for Mac)

The following provides brief information about the PC viewer's screen layout.

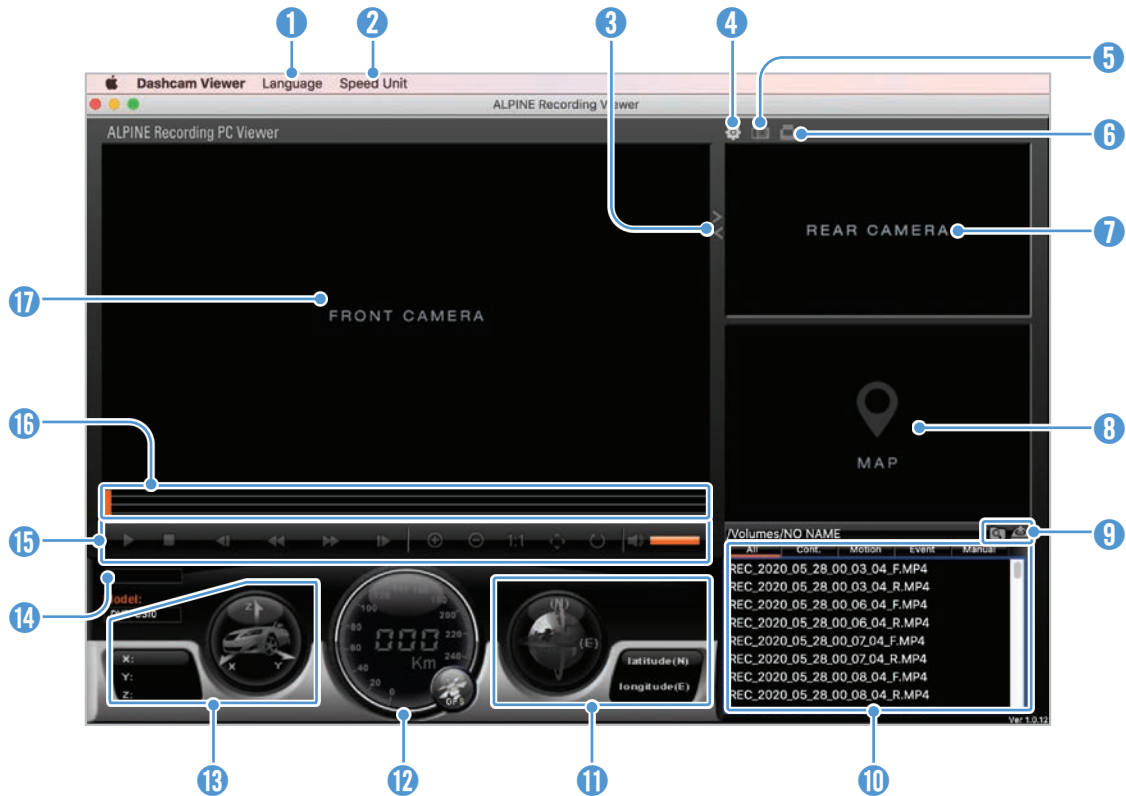

Number	Description
1	Set the language for the PC viewer.
2	Set the speed unit.
3	Switch between the front and rear videos.
4	View or configure the dash cam settings.
5	Save the current scene.
6	Print the current scene.
7	Displays the current rear video.
8	Displays the map screen.
9	Open a file, or save a video with a different name.
10	Displays the playlist.
11	Displays the GPS information at the time of recording.
12	Indicates the vehicle's driving speed at the time of recording.
13	Indicates the G sensor value at the time of recording.
14	Displays the current and total running time of the current video.
15	Play or control a video.
16	Displays the progress of video playback.
17	Displays the current front video. Right-click this pane to display the current video in full screen.

5.2.5 Playing recorded videos on the PC viewer (for Mac)

Follow the instructions to play recorded videos.

- 1 Turn off the product and remove the memory card.
- 2 Insert the memory card into your Mac using a SD card reader or SD card adapter provided.
- 3 Open the PC viewer.
- 4 Click  and locate the memory card.

The video files in the memory card will be automatically added to the playlist in the bottom-right corner of the PC viewer screen. The playlist section layout is as follows.

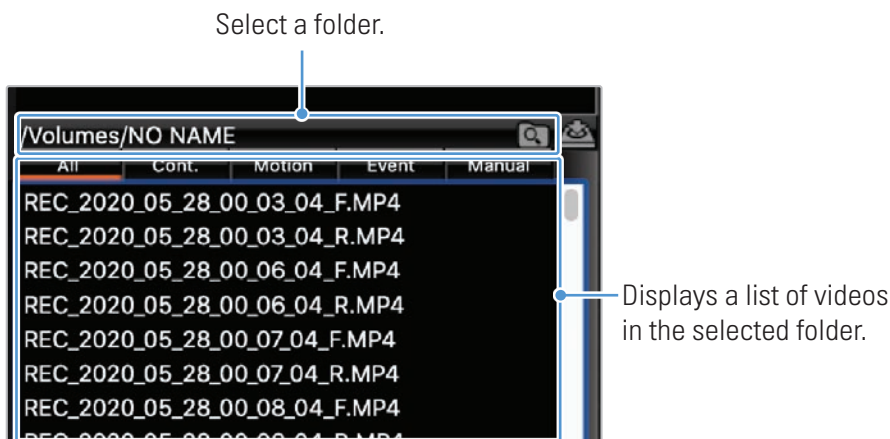

- 5 Double-click a video file after selecting a video folder, or click the Play (▶) button after selecting a video file. The selected video file will be played.

6. Settings

You can set the product features according to your needs and preferences using the mobile viewer or the PC viewer. The following procedures are based on the mobile viewer.



The product will stop recording while configuring settings on the mobile viewer.

6.1 Managing the memory card

From the mobile viewer, tap **Dash Cam settings > Memory Card Settings** to manage the memory card settings.

Options	Description
Memory Partition	You can partition the memory card to adjust the storage space for different types of video recordings. Select from Continuous Priority/Incident Priority/Parking Priority/Manual Priority/Driving Recording Only for the memory partition type.
Formatting Memory Card	You can format the memory card that is inserted in the product. In Formatting Memory Card , tap Format > OK to proceed with formatting the memory card.



Do not disconnect the power or remove the memory card from the product while partitioning or formatting. Doing so may cause serious damage to the data stored in the memory card.

6.2 Setting the Camera

From the mobile viewer, tap **Dash Cam settings > Camera Settings** to adjust the camera settings.

Options	Description
Brightness-front	You can set the brightness of the front view recording. Select from Dark/Mid/Bright for the brightness of the front camera.

6.3 Setting recording features

From the mobile viewer, tap **Dash Cam settings > Record Settings** to manage the recording features settings.

Options	Description
Continuous Mode Incident Recording Sensitivity	You can set the detection sensitivity for recording when an impact is detected while driving. When you set the sensitivity, you must consider the road conditions, traffic situation, or your driving style. Select from Disabled/Lowest/Low/Mid/High for the sensitivity.
Privacy Recording	You can set the privacy recording feature to delete your recorded files after a set amount of time to protect the privacy of others. Select from Disables/1min(max. 2min)/3min(max. 4min) for the privacy recording setting.  This feature is only available in Europe.
Parking Mode	You can set the operating mode of the product while the vehicle is parked. Select from Disabled/Motion Detection/Energy Saving for the parking mode.
Impact Sensitivity in Parking Mode	You can set the detection sensitivity for recording when impact is detected while parking. Select from Lowest/Low/Mid/High/Highest for the sensitivity.
Motion Detection Sensitivity	The motion detection feature records a video when a moving object is detected near your vehicle. Select from Lowest/Low/Mid/High/Highest for the sensitivity.
Record Timer	When you activate the record timer feature, the product will record a video in parking mode for a preset time. Select from 3hrs/6hrs/12hrs/24hrs/48hrs/72hrs for the recording time.
Battery Protection	The battery cut-off voltage is set to 12V (11.6-12.3) by default.
Wintertime Battery Protection	To protect the battery in wintertime, you can turn off the power at a voltage that is +0.2V higher than the voltage set in the Battery cutoff voltage. Select the month(s) to apply the battery protection feature.



- To use parking mode, you must install the hardwiring cable. If continuous power is not supplied to the product, the product will stop recording when the vehicle engine is turned off.
- The vehicle's battery will not be charged while the vehicle is parked. If you record in parking mode for an extended period, the vehicle's battery may be depleted and you may not be able to start the vehicle.



- For more information about parking mode, refer to "3.5 Using parking mode".
- If the off voltage value is too low, the product may consume the battery completely depending on various conditions, such as vehicle type or temperature.

6.4 Read Safety settings

From the mobile viewer, tap **Dash Cam settings > Road Safety Settings** to manage the road safety features.

Options	Description
Safety Cameras	When the vehicle approaches or passes the speed limit zone, the safety camera alert system will collect GPS signals and safety camera data. Select from Enabled/Disabled for the safety camera feature.
Mobile Zone Alert	The mobile zone alert feature audibly warns the driver about speed cameras and mobile speed zones in the driver's area. Select from Enabled/Disabled for the mobile zone alert feature.

6.5 Configuring the system settings

From the mobile viewer, tap **Dash Cam Settings > System Settings** to configure the hardware system settings.

Options	Description
Language	Select the desired language.
Volume	Select the desired volume level.
Time Zone	Select the desired time zone.
Daylight Saving	Select from Enabled/Disabled for the daylight saving.
Speed Unit	Select from km/h/mph for the speed unit.
Speed Stamp	The driving speed during recording can be recorded in a file. Select from Enabled/Disabled for the speed stamp.



If you select **0** for the volume level, the voice guidance will be disabled.

7. Accessing the product information

New users may benefit from the basic product information that can be accessed from the Menu screen.

7.1 Viewing product information

From the mobile viewer, tap **Dash Cam Info** to view product information. The following product information menus will be displayed on the screen.

- Model Name
- LOCAL ID
- Firmware Ver.
- GPS Info
- Memory Size

7.2 Accessing and configuring the GPS

A GPS module is used to include the location data in the recorded videos. From the mobile viewer, tap **Dash Cam Info > GPS Info** to view the GPS features. The connection status, signal strength, time (UTC), vehicle speed, current altitude, and Horizontal Dilution of Precision (HDOP) will be displayed on the screen.

Tap  to initialize the GPS, and allow it to locate the current position.



Horizontal Dilution of Precision (HDOP)

HDOP is a value that refers to GPS deviation due to satellite positioning.

8. Upgrading the firmware

A firmware upgrade is provided to enhance the product's features, operation or to increase stability. For optimal operation of the product, ensure that you keep the firmware up to date.

Follow the instructions to upgrade the firmware.

- 1 On your PC, open a web browser and go to Alpine website.
- 2 Select the product and download the latest firmware upgrade file.
- 3 Unzip the downloaded file.
- 4 Disconnect power to the product and remove the memory card.
- 5 Open the memory card on a PC and copy the firmware upgrade file to the root folder of the memory card.
- 6 While the power is disconnected from the product, insert the memory card into the memory card slot on the product.
- 7 Connect the power cable to the product, and then turn on the power (ACC ON) or start the engine to turn on the product. The firmware upgrade starts automatically, and the system will restart once the firmware update is completed.



Do not disconnect the power or remove the memory card from the product during the upgrade. Doing so may cause serious damage to the product, or to the data stored in the memory card.

9. Troubleshooting

The following table lists the problems users may encounter while using the product and measures to resolve them. If the problem persists after taking the measures provided in the table, contact the customer service center.

Problems	Solution
Cannot power on the product	<ul style="list-style-type: none">• Make sure the power cable (the car charger or the hardwiring cable) is connected to the vehicle and the product properly.• Check the vehicle's battery level.
The voice guide and/or buzzer do not sound.	Check if the volume is set to the minimum.
The video is unclear or hardly visible.	<ul style="list-style-type: none">• Ensure that the protective film on the camera lens has been removed. The video may look unclear if the protective film is still on the camera lens.• Check the installation location of the front or rear camera, turn on the product, and then adjust the camera's viewing angle.
The memory card cannot be recognized.	<ul style="list-style-type: none">• Ensure that the memory card has been inserted in the correct direction. Before inserting the memory card, ensure that the metal contacts on the memory card are facing toward the lens of the product.• Turn off the power, remove the memory card, and then check to ensure that the contacts in the memory card slot are not damaged.• Ensure that the memory card is an authentic product distributed by Alpine. Alpine does not guarantee compatibility and normal operation of third-party memory cards.
The recorded video cannot be played on a PC.	The recorded videos are stored as MP4 video files. Ensure that the video player installed on your PC supports the playback of MP4 video files.
GPS signal cannot be received even though the external GPS receiver is installed.	The GPS signal may not be received in out-of-service areas, or if the product is located between tall buildings. Also, GPS signal reception may not be available during storms or heavy rain. Try again on a clear day at a location that is known to have a good GPS reception. It may take up to 5 minutes until GPS reception is established.

Before contacting a service center

Please back up all important data stored in the memory card. The data in the memory card may be deleted during repair. Every product requested for repair is regarded as a device that has had its data backed up. The customer service center does not back up your data. Alpine is not responsible for any loss, such as data loss.

10. Specifications

To see the product specifications, refer to the following table.

Item	Specification	Remarks
Model name	DVR-C310R / DVR-C310S / RVC-C310	
Dimensions / Weight	98.5 x 40.6 x 26.9 mm / 61 g (except mount)	Rear camera: 60.5 x 32.3 x 26.7 mm / 24.8 g
Memory	microSD card	16 GB, 32 GB, 64 GB, 128GB (UHS-I)
Recording mode	Continuous Rec	Records videos in 1-minute segments (dual channels are supported for recording the front and rear view)
	Incident Rec	Records 10 seconds before and after the incident (total 20 seconds)
	Manual Rec	Records from 10 seconds before and 50 seconds after manually starting the recording (total 1 minute)
	Parking Rec (parking mode)	Motion detection / Energy saving
Camera sensor	2.1M Pixels, CMOS, 1080p	Rear camera: 1.0M Pixels
Angle of view (Lens)	Approximately 144° (diagonally)	Rear camera: approximately 140°
Video	FHD (1920 x 1080 @ 30fps / H.264 / MP4)	Rear camera: HD (1080 x 720 @ 30fps / H.264 / MP4)
Audio	PCM (Pulse code modulation)	Built-in microphone
Acceleration sensor	3-axis acceleration sensor (3D, ±3G)	
GPS	External GPS	
Wireless	Single-band 2.4GHz, 802.11 b/g/n	
Power consumption	2ch: 3.6 W / 1ch: 2.7 W	Except for the fully charged supercapacitor / GPS
LED indicator	Wi-Fi LED, Status LED	
Alarm	Built-in speakers	Voice guide (buzzer sounds)
Operating temperature	-4 – 140°F / -20 – 60°C	

For the approximate recording times of each memory partition setting, refer to the tables below.



- For more information about the memory partition settings, refer to "6.1 Managing the memory card" on page 29.
- For more information about the parking mode, refer to "3.5 Using parking mode" on page 22.

• Continuous Priority

Parking Mode	Card Size	Continuous Rec	Incident Rec	Manual Rec	Motion Detection (while parking)	Parking Incident
Motion Detection	16 GB	Approx. 94 min	Approx. 50 min	Approx. 13 min	Approx. 91 min	Approx. 38 min
	32 GB	Approx. 188 min	Approx. 100 min	Approx. 25 min	Approx. 181 min	Approx. 75 min
	64 GB	Approx. 376 min	Approx. 200 min	Approx. 50 min	Approx. 362 min	Approx. 150 min
	128 GB	Approx. 752 min	Approx. 400 min	Approx. 100 min	Approx. 724 min	Approx. 300 min
Energy Saving	16 GB	Approx. 94 min	Approx. 50 min	Approx. 13 min	Approx. 91 min	Approx. 38 min
	32 GB	Approx. 188 min	Approx. 100 min	Approx. 25 min	Approx. 181 min	Approx. 75 min
	64 GB	Approx. 376 min	Approx. 200 min	Approx. 50 min	Approx. 362 min	Approx. 150 min
	128 GB	Approx. 752 min	Approx. 400 min	Approx. 100 min	Approx. 724 min	Approx. 300 min

• Incident Priority

Parking Mode	Card Size	Continuous Rec	Incident Rec	Manual Rec	Motion Detection (while parking)	Parking Incident
Motion Detection	16 GB	Approx. 68 min	Approx. 88 min	Approx. 13 min	Approx. 106 min	Approx. 87 min
	32 GB	Approx. 136 min	Approx. 176 min	Approx. 25 min	Approx. 211 min	Approx. 173 min
	64 GB	Approx. 272 min	Approx. 352 min	Approx. 50 min	Approx. 422 min	Approx. 346 min
	128 GB	Approx. 544 min	Approx. 704 min	Approx. 100 min	Approx. 844 min	Approx. 692 min
Energy Saving	16 GB	Approx. 68 min	Approx. 88 min	Approx. 13 min	Approx. 106 min	Approx. 87 min
	32 GB	Approx. 136 min	Approx. 176 min	Approx. 25 min	Approx. 211 min	Approx. 173 min
	64 GB	Approx. 272 min	Approx. 352 min	Approx. 50 min	Approx. 422 min	Approx. 346 min
	128 GB	Approx. 544 min	Approx. 704 min	Approx. 100 min	Approx. 844 min	Approx. 692 min

- Parking Priority

Parking Mode	Card Size	Continuous Rec	Incident Rec	Manual Rec	Motion Detection (while parking)	Parking Incident
Motion Detection	16 GB	Approx. 53 min	Approx. 42 min	Approx. 13 min	Approx. 314 min	Approx. 38 min
	32 GB	Approx. 105 min	Approx. 83 min	Approx. 25 min	Approx. 627 min	Approx. 75 min
	64 GB	Approx. 210 min	Approx. 166 min	Approx. 50 min	Approx. 1,254 min	Approx. 150 min
	128 GB	Approx. 420 min	Approx. 332 min	Approx. 100 min	Approx. 2,508 min	Approx. 300 min
Energy Saving	16 GB	Approx. 53 min	Approx. 42 min	Approx. 13 min	Approx. 314 min	Approx. 38 min
	32 GB	Approx. 105 min	Approx. 83 min	Approx. 25 min	Approx. 627 min	Approx. 75 min
	64 GB	Approx. 210 min	Approx. 166 min	Approx. 50 min	Approx. 1,254 min	Approx. 150 min
	128 GB	Approx. 420 min	Approx. 332 min	Approx. 100 min	Approx. 2,508 min	Approx. 300 min

- Manual Priority

Parking Mode	Card Size	Continuous Rec	Incident Rec	Manual Rec	Motion Detection (while parking)	Parking Incident
Motion Detection	16 GB	Approx. 53 min	Approx. 63 min	Approx. 60 min	Approx. 38 min	Approx. 38 min
	32 GB	Approx. 105 min	Approx. 125 min	Approx. 120 min	Approx. 75 min	Approx. 75 min
	64 GB	Approx. 210 min	Approx. 250 min	Approx. 240 min	Approx. 150 min	Approx. 150 min
	128 GB	Approx. 420 min	Approx. 500 min	Approx. 480 min	Approx. 300 min	Approx. 300 min
Energy Saving	16 GB	Approx. 53 min	Approx. 63 min	Approx. 60 min	Approx. 38 min	Approx. 38 min
	32 GB	Approx. 105 min	Approx. 125 min	Approx. 120 min	Approx. 75 min	Approx. 75 min
	64 GB	Approx. 210 min	Approx. 250 min	Approx. 240 min	Approx. 150 min	Approx. 150 min
	128 GB	Approx. 420 min	Approx. 500 min	Approx. 480 min	Approx. 300 min	Approx. 300 min

- Driving Recording Only

Parking Mode	Card Size	Continuous Rec	Incident Rec	Manual Rec	Motion Detection (while parking)	Parking Incident
Motion Detection	16 GB	Approx. 123 min	Approx. 42 min	Approx. 13 min	-	-
	32 GB	Approx. 246 min	Approx. 83 min	Approx. 25 min	-	-
	64 GB	Approx. 492 min	Approx. 166 min	Approx. 50 min	-	-
	128 GB	Approx. 984 min	Approx. 332 min	Approx. 100 min	-	-
Energy Saving	16 GB	Approx. 123 min	Approx. 42 min	Approx. 13 min	-	-
	32 GB	Approx. 246 min	Approx. 83 min	Approx. 25 min	-	-
	64 GB	Approx. 492 min	Approx. 166 min	Approx. 50 min	-	-
	128 GB	Approx. 984 min	Approx. 332 min	Approx. 100 min	-	-



Hereby, Alpine Electronics (Europe) declares that the radio equipment type DVR-C310R, DVR-C310S is in compliance with Directive 2014/53/EU.

The full text of the EU declaration of conformity is available at the following internet address: <http://www.alpine.com/e/research/doc/>

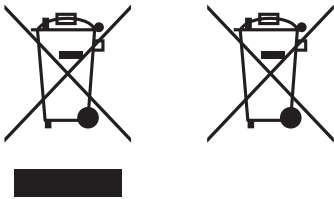

Information on Disposal of Old Electrical and Electronic Equipment and Battery (applicable for countries that have adopted separate waste collection systems)

If you want to dispose this product, do not mix it with general household waste. There is a separate collection system for used electronic products in accordance with legislation that requires proper treatment, recovery and recycling. Contact your local authority for details in locating a recycle facility nearest to you. Proper recycling and waste disposal will help conserve resources whilst preventing detrimental effects on our health and the environment.

WiFi (IEEE 802.11b/g/n) in the 2.4GHz ISM band (2412 ~ 2472MHz)

Maximum Power [17.99dBm / 63mW (EIRP)]

Rx only: GNSS (1563~1610MHz), GPS L1 (1575.42MHz) + GLONASS L1 (1602.00MHz)

Important information on the software

About the software licence of the product

The software installed in the product contains open-source software.

See the following Alpine website for details on the open source software.

www.alpine-usa.com

www.alpine-europe.com

www.alpine-usa.com
www.alpine-europe.com

Ver. 1.0 (Oct. 2020)

ALPINE ELECTRONICS OF AMERICA, INC.

1500 Atlantic Boulevard, Auburn Hills,
Michigan 48326, USA
Phone: 1-800-ALPINE-1 (1-800-257-4631)

ALPS ALPINE EUROPE GmbH

Ohmstrasse 4
85716 Unterschleissheim
Germany

For contact information on your respective country, please visit www.alpine-europe.com.